

TM: Threaded pipe mounting

1. Remove the plugging screw (Figure 17).
2. Pass the wire in the threaded pipe through the hole and connect to the wire of the terminal accordingly (Figure 18).
3. After the wiring is completed, put the threaded pipe into the hole, turn it clockwise to tighten it, and then tighten the nearby fixing screw and hold it against the threaded pipe(Figure 19).
4. Lock the driver box cover with screws(Figure 20).
5. After installation, please wire in accordance with local connection standard, and make sure to take good waterproof measures at the joint of conduit

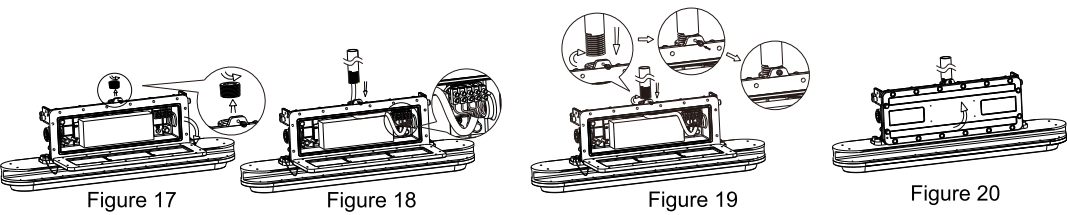

Wire guard installation method (optional)

1. There are already 8 M3 screw holes on the cover of the fixture (Figure 21).
2. Before installing the fixture, put a wire guard on the fixture cover, as shown in(Figure 22).
3. Fix the wire guard with screws (Figure 23).

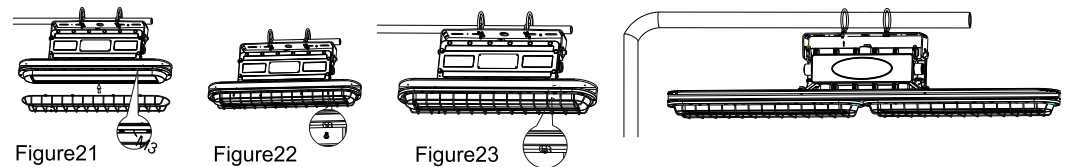

Second-Retention Point

1. Wire rope is necessary for the fixture. (Figure 24).
2. Surround the wire rope to the wire rope fixing position in the middle of the fixture. Tighten the wire rope (Figure 25).
3. Fasten the other end of the wire rope to the outlet box or the mounting structure of the outlet box. (Figure 26).

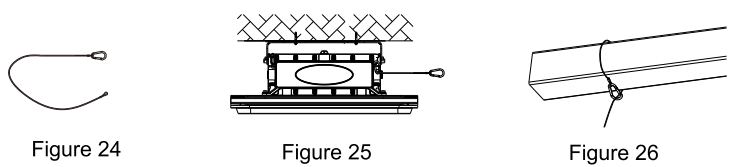

Warning / Avertissement:
 MIN 90°C SUPPLY CONDUCTORS.
 THIS PRODUCT MUST BE INSTALLED IN ACCORDANCE WITH THE APPLICABLE INSTALLATION CODE BY A PERSON FAMILIAR WITH THE CONSTRUCTION AND OPERATION OF THE PRODUCT AND THE HAZARDS INVOLVED.
 LES FILS D'ALIMENTATION 90°C MIN.
 CE PRODUIT DOIT ÊTRE INSTALLÉ SELON LE CODE D'INSTALLATION PERTINENT, PAR UNE PERSONNE QUI CONNAÎT BIEN LE PRODUIT ET SON FONCTIONNEMENT AINSI QUE LES RISQUES INHÉRENTS.

Cautions:

1. Can not use the electric generator to test the LED fixture.
2. Please abide by related country, regional and local law and regulations when install this fixture.
3. Please turn off the power before installation or maintenance.
4. Proper earth grounding is required to ensure safety.

Notice:

1. To avoid possibility of electrical shock or fire, the installation personnel must have professional electric knowledge.
2. Please wear gloves to avoid injury before installation.
3. If any smoke or spark of the wire happened, please turn off the power immediately and notify relevant personnel.

Attention:

1. Please check if there is any damage during shipping. If so, please contact manufacturer timely.
2. Please read the installation instruction carefully to check whether all the accessories are complete. After confirmation, install the fixture according to installation steps.

Wiring Diagram & Instruction:

- 3 dimming functions are available in this Hazardous Location LED Linear Light:
1. Constant current can be achieved by 1-10VDC dimming, PWM signal dimming, (Dimming wire for 1-10 VDC or PWM signal dimming should be connected to terminal block in fixture through suitable conduit; Please check the label next to terminal block for polarity of wire) ;
 2. Please choose the appropriate dimming way according to your needs. You can also choose not to use this function.
 3. Loosen the screws of the driver box cover, as shown in Figure (0-1), the screws will not fall off;
 4. Open the cover, there is a hanging rope at the lower left corner to prevent falling off (Figure 0-2);
 5. Unscrew the 3/4 "NPT nut, install suitable conduit to the conduit opening, pull the wire through the conduit hole (Figure0-2), and connect it to the 5PIN terminal block; Wire connected to terminal block should be Aluminum or Copper Conductors. Conectors should be secured by Torque: 4.4 in-lbs. See label at the terminal block for wiring.
 6. Lock the driver box cover with screws.(Figure 0-3)
 7. After installation, please ensure all the wiring is in accordance with local connection standard.
- Note:** All the conduit openings must be closed by conduit or NPT nut. Whenever installing the NPT nut or conduit during installation or maintenance, please ensure silicone gel is added around the threads according to Figure -5.

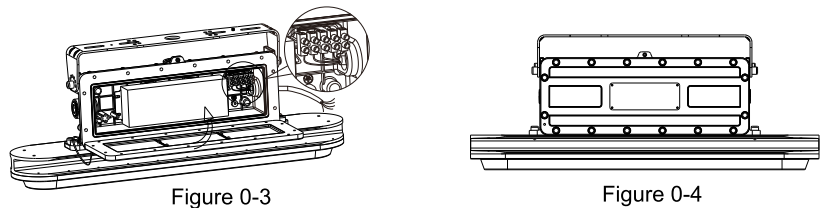
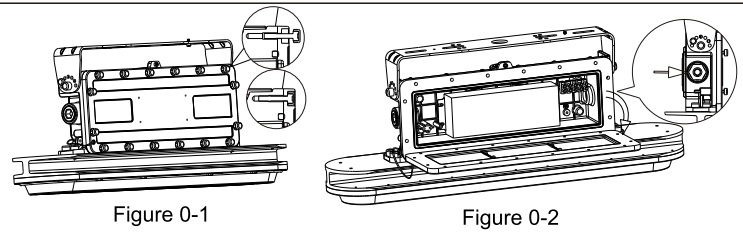

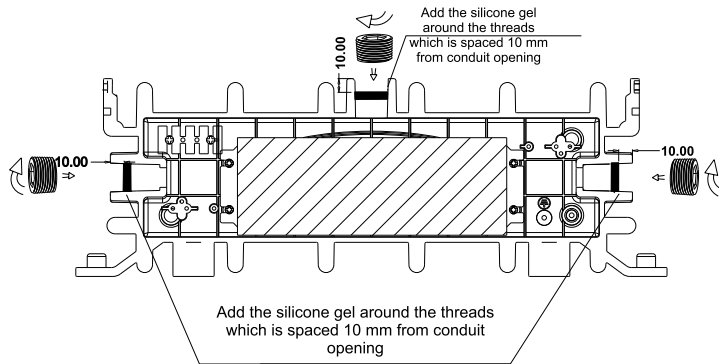

Figure 0-5

Installation Methods:

FM : bracket wall mounting ; CM : ceiling mount ; PM : pole mounting ; HM : hanging chain mounting ; TM : threaded pipe mounting ;
(Choose the appropriate installation method according to your needs)

FM: bracket wall mounting:

1. Make marks on the walls, and then drill holes on the marks(Figure 1-1).
2. Use a hammer to put the expansion screws into the holes (Figure 2-1).
3. The holes on the bracket should be aligned with the expansion screws (Figure 3).
4. Tighten the nut of the screws (Figure 4).
5. Hang the fixture into the lifting hook or chain and protect it from falling.(Figure 5).
6. Wiring according to the instructions on the first and second pages.
7. After installation, please wire in accordance with local connection standard, and make sure to take waterproof measures at the joint of conduit. Users can adjust 30-60-90 degree to left or right from vertical downward direction by adjusting the screw on the bracket. (Figure 5 .Figure A).

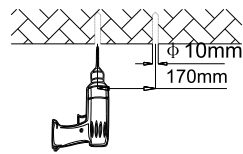

Figure 1-1

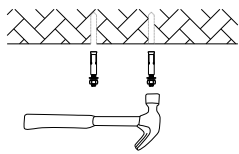

Figure 2-1

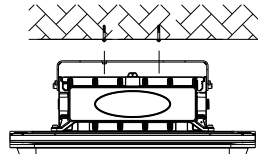

Figure 3

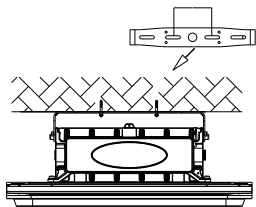

Figure 4

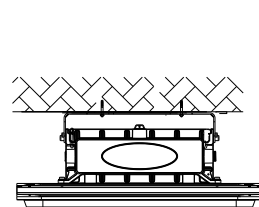

Figure 5

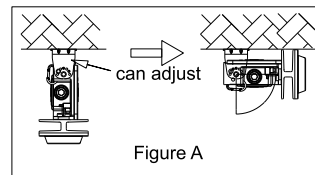

Figure A

CM:Ceiling mount

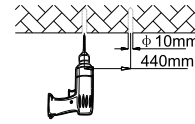

Figure 1-2

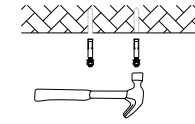

Figure 2-2

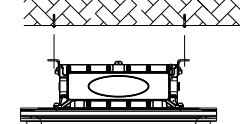

Figure 6

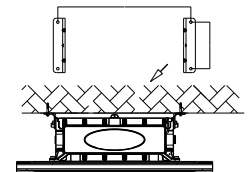

Figure 7

1. Use a chalk or sharp tool to mark signs on the top of the ceiling, then drill holes on the signs by electric drill (Figure 1-2).
2. Use a hammer to put the expansion screws into the holes (Figure 2-2).
3. The holes on the bracket should be aligned with the expansion screws, then push the fixture to one side (Figure 6)
4. Tighten the nut of the screws (Figure 7)..
5. Wiring according to the instructions on the first and second pages.
6. After installation, please wire in accordance with local connection standard, and make sure to take good

PM: Pole mounting

1. Can be equipped with 4 sizes of round tube light poles, the sizes are as following : $\phi 21\text{mm}$ 、 $\phi 27\text{mm}$ 、 $\phi 48\text{mm}$ 、 $\phi 60\text{mm}$ (Figure 9).
2. Select the appropriate bolts (Figure 9), assemble the bolts to the fixture, and install the nuts (Figure 10).
3. Insert the U-shaped bolt of the fixture into the round pipe (Figure 11); tighten the bolt M6 nut, and the other M4 hex screw from the bottom of the bracket to fix the round rod (Figure 12).
4. Wire guard is optional, can be installed according to the actual application (Figure 12).
5. Wiring according to the instructions on the first and second pages.
6. After installation, please wire in accordance with local connection standard, and make sure to take good waterproof measures at the joint of conduit

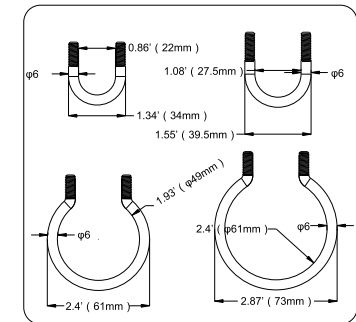

Figure 9

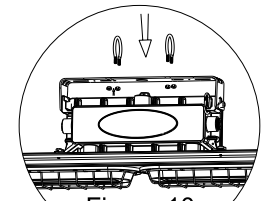

Figure 10

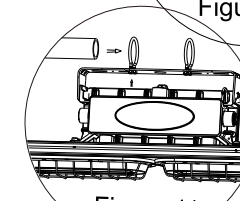

Figure 11

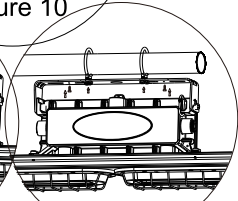

Figure 12

HM: Hanging chain mounting

1. There are pre-installed rings or hooks to hang the chain hook.
2. Hang the fixture into the lifting hook or chain.(Figure 15) (Figure 16)
3. After installation, please wire in accordance with local connection standard, and make sure to take good waterproof measures at the joint of conduit

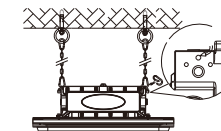

Figure 15

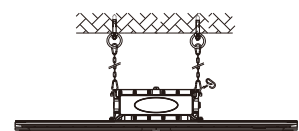

Figure 16