

3-1: Backup driver

Step1. Open junction box with screw driver.

Step2. Connect the input wires on each backup driver and fixture driver via suitable knock out, then complete the junction.

Wiring diagram (Maintained)

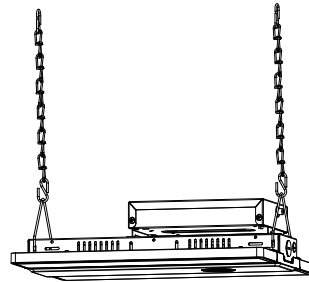
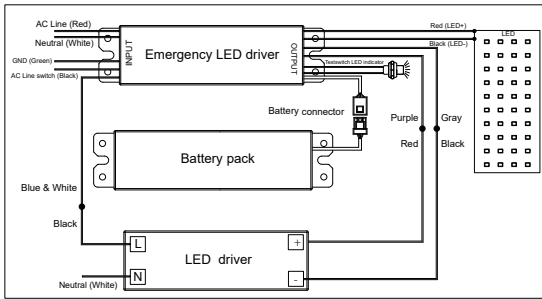

3-2: Backup driver

Step1. Assemble the bracket onto the back of the light fixture.

Step2. Assemble the emergency power supply to the bracket, and then connect according to the wiring mode.

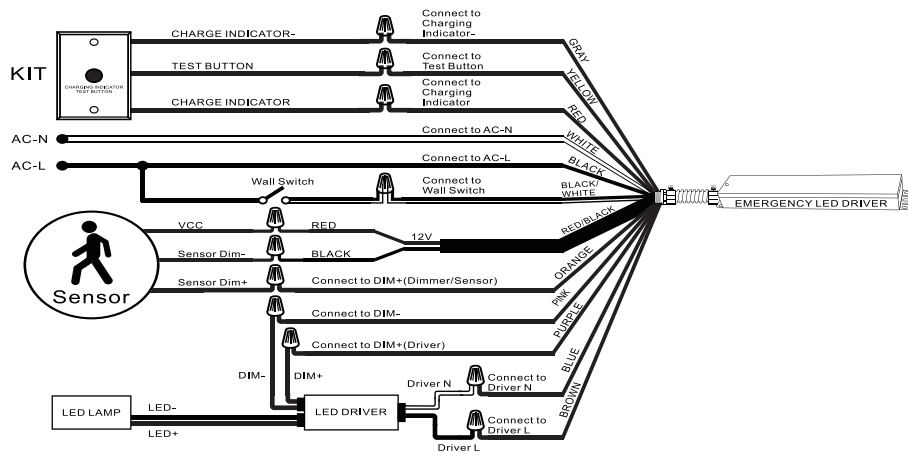
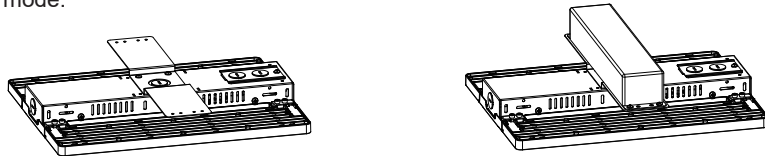

CCT & Wattage Adjustment

Wattage adjustment switch + CCT tunable switch

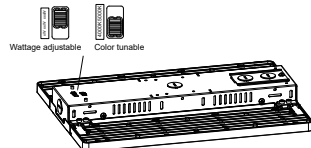

LED Linear High Bay Installation Instruction

Cautions:

1. Do not use any electric generator to test the LED light.
2. Please abide by related country, regional and local law and regulations when installing this fixture.
3. Please turn off the power before installation or maintenance.
4. Proper earth grounding is required to ensure safety.

Notice:

1. To avoid possibility of electrical shock or fire, the installation personnel must have professional electric knowledge.
2. Please wear gloves to avoid injury before installation.
3. If any smoke or spark of the wire happened, please turn off the power immediately and notify relevant personnel.
4. Please use listed strain relief bushing when connecting the supply cord to the outlet box.

Attention:

1. Please check if there is any damage during shipping. If so, please contact manufacturer timely.
2. Please read the installation instruction carefully to check whether all the accessories are complete. After confirmation, install the fixture according to installation steps.

Wiring Diagram & Instruction:

3 dimming functions are available in this high bay light:

1. Constant current can be achieved by 0/1-10VDC dimming;
2. PWM signal dimming;
3. Variation of resistance unit dimming.

Description:	
This product is 0/1-10V dimming, below dimmers are recommended:	
Brand	Model
LUTON	NTSTV-DV
LEVITON	DS710-10Z / IP710
LEGRAND	RH4FBL3PW

Wiring Instruction

L: Black,
 N: White,
 ⊕ : Green/Yellow
 DIM +
 DIM -
 (As for the wire color of DIM+ and DIM-, pls check the light label.)

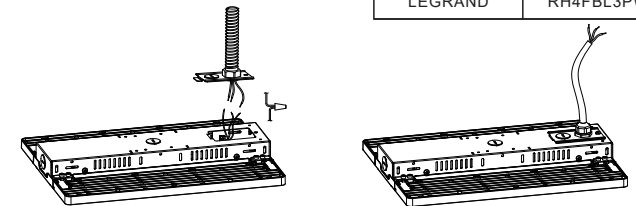

Please choose the appropriate dimming way according to your needs. You can also choose not to use this function.

*The product can not be connected to a dimming device when it's equipped with Motion Sensor.

Three Installation: Chain/Cable installation, 3/4" NPT Installation, Surface Mounting
(Please choose the most suitable installation method for the purchased product as per your needs)

A.Hanging Installation: (Chain/Cable)

- Step1.Hook up the chain; (Figure 1)
- Step2.Connect the chain with fixture; (Figure 1)
- Step3. Fix the chain on the rail, adjust the chain length as per need; (Figure 1)
- Step4.After fixed , choose suitable wiring knock out, connect the wires according to local standard and code.

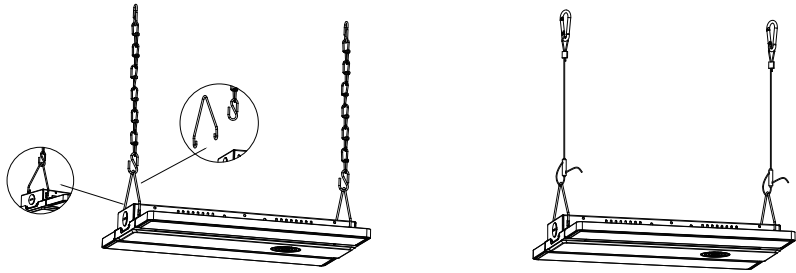

Figure 1

B.3/4"NPT Installation:

- Step1.Mount the bracket on 3/4"NPT (Figure 2);
- Step2. Lock fixture on the bracket (Figure 3);
- Step3. Connect the wires according to local standard and code.
- Step4 Lock side brackets with screw driver (Figure 4).

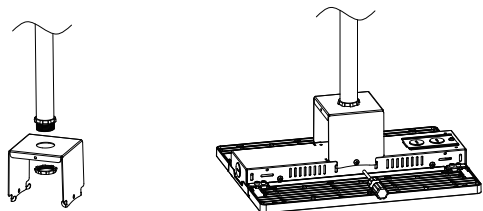

Figure 2

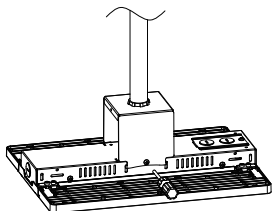

Figure 3

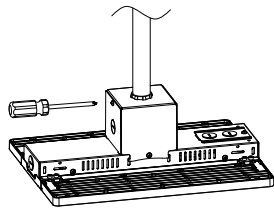

Figure 4

C.C.Surface Mounting: (If this bracket is used for the fixture, backup driver solution cannot be chosen)

- Step1.Mount the bracket on the rail or ceiling (Figure 5);
- Step2. Assemble the lamp on the bracket and fix it with screws (Figure 6);
- Step3. After mounting, choose suitable wiring knock out and connect the wires according to local standard and code.

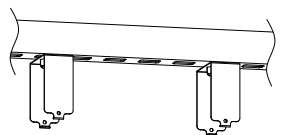

Figure 5

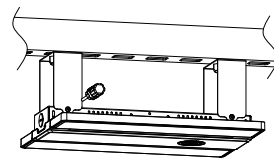

Figure 6

Extra Accessory Option Installation: 1:Wire Guard, 2:Motion Sensor / PIR Sensor,3: Backup driver.

1.Wire Guard: (Purchase the correct size wire guard from manufacturer)

- Step1. Place the wire guard on the lamp and fix it with screws (Figure 7).



Figure 7

2-1. Motion Sensor /PIR Sensor: (Both sensor are with same installation)

- Step1.Connect the wires according to the wiring diagram. (Figure 8)

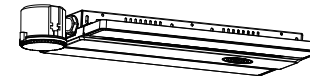
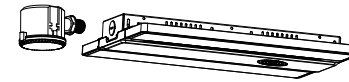
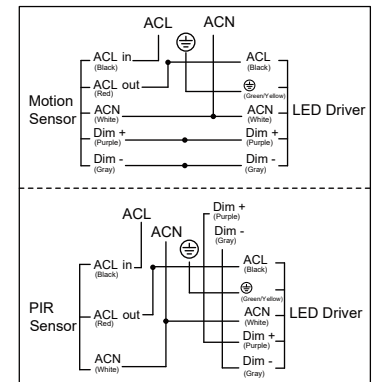

Figure 8

Wiring Instruction



2-2. DC Motion Sensor / PIR Sensor (Both sensors are with the same installation method)

- Step1. Use a screwdriver to remove the 1/2 plug from the sensor;(Figure 9)
- Step2. Twist-lock the DC sensor to the base to make it work properly, use a remote control to adjust the working mode as per demand.(Figure 10)

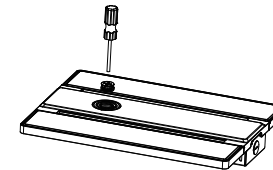

Figure 9

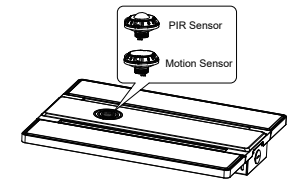

Figure 10