



The DUO Selectable Panel provides a low profile, low glare, uniform source ambient lighting fixture. It includes two DIP switches to easily and reliably adjust CCT and lumens, making it a one fits all solution for indoor commercial lighting applications including but not limited to offices, retail space, and showrooms. The DUO simplifies the work of specifiers, designers, and contractors, who often must consider the lighting requirements of multiple rooms when completing interiors.

Product Specs	
Input Voltage (VAC)	100-277V Standard [†]
CRI	80+
CCT (K)	CCT ranges vary, see ordering table for specific luminaire
PF	.95
THD	<20%
Control	0-10V Dimming Standard
Color**	White (RAL 9003)
Housing	UV resistant, Aluminum Frame, Galvanized Steel Driver Compartment
Lens	PMMA Lens with PS Diffuser
Temperature Range	-10°C to 40° C
L70*	See Lumen Maintenance Table for lifetime values
Limited Warranty	5 Years

*L70 data is calculated based on LM80 and ISMT reports

[†] For higher voltage application a step down transformer is recommended

Project Details		Type
Project:		
Product:		
Prepared by:		
Notes:		

APPLICATIONS		
Application	Small / Partitioned Office	
Fixture Type	Lay-in Panel / Troffer	
Office and Meeting Space	X	
Educational Facilities	X	
Industrial and Distribution		
Hospital and Healthcare Facilities	X	
Garage and Parking Lot		
Parks and Recreation		

ENABLED: Bluetooth DLC Tru Blu SILVAIR

CERTIFICATIONS AND COMPATIBILITIES

Order Format Example: FPBL-T-24T-40W-02

Product ID	Dimensions	-	Wattage	
FPBL-T	14T=1'x4' CCT & Lumen Selectable	-	30W=15W/20W/30W Selectable	01°=3500K/4000K/4500K/ 5000K Selectable
	22T=2'x2' CCT & Lumen Selectable	-		
	24T=2'x4' CCT & Lumen Selectable	-	40W=25W/30W/35W Selectable	02= 3000/3500/4000/ 4500/5000 Selectable

INFORMATION FOR LIGHTING CONTROLS APPLICATIONS

LLLC - Luminaire Level Lighting Control (Mesh Network)	LALC - Local Area Lighting Control (Circuit Level)	SAFC - Stand Alone Fixture Control
<p>LLLC</p>	<p>LALC</p>	<p>SAFC</p>
		<p>Pole POLE</p>
		<p>*possibly rebated on fixture only</p>
<p>Control-luminaire groupings typified by needs to a space or user, coordinated via wireless signals, executed at each luminaire. LLLC and networked solutions are highlighted by ability to operate independently or in mesh coordination. Note: they are not related by a power circuit.</p>	<p>LALC solutions are highlighted by their “many to one” arrangements. This can save on hardware costs with minimal labor increases. Characteristically they are linked (related) by power or control wires.</p>	<p>SALC solutions have sensors that typically only detect and individually control a single fixture. Characteristically they have A) 1:1 sensor to fixture relationship; B) sensor integrally wired and/or affixed to fixture; C) Likely to have physical settings on the sensor, but may have hand held program tool.</p>

CONTROLS, OPTIONS, AND ACCESSORIES

↓ [CLICKABLE LINKS](#) ↓

LLLC - LUMINAIRE LEVEL LIGHTING CONTROL (MESH NETWORK)

ATG Code	Description	Model Number
W7	Wireless Occupancy Wall Switch	PSC-DM-WS-100-BLE-SR
W8	Wireless Dimmer Wall Switch	PSC-DM-I-WS-100-BLE-SR
W15	Ceiling Mount PIR Occupancy Sensor	PSC-ND-I-CM-DC-BLE-SR
P5	Room controller, KO mounted, 120-277In / 12VC and 0-10V out / 16A	PSC-WCM-450-BLE-SR

LALC - LOCAL AREA LIGHTING CONTROL (CIRCUIT LEVEL)

ATG Code	Description	Model Number
W3	Bi-Level Microwave Remote Mount Occupancy Sensor	PSC-BL-M-RT-DC0-BLE-SR
P7	12V Power Supply for fixture mount w/relay	PSC-AC-PP-700C

SAFC - STAND ALONE FIXTURE CONTROL

ATG Code	Description	Model Number
—	Contact ATG Sales	—

ACCESSORIES

ATG Code	Description	Model Number
SMK14	1X4 Surface Mount Kit	HAC-CLMB0-0312A0-RS
SMK22	2x2 Surface Mount Kit	HAC-CLMB0-0600A0-RS
SMK24	2x4 Surface Mount Kit	HAC-CLMB0-0612A0-RS
EM	Emergency Driver and Battery	EMH-08170-FY
—	Flange Kit 1x4	FK-FPEL14-01
—	Flange Kit 2x2	FK-FPEL22-01
—	Flange Kit 2x4	FK-FPEL24-01

** Contact Sales for lead time and pricing on customized finish color

◊ Contact ATG for ordering of "-01" configurations

ELECTRICAL

Long-life LEDs, coupled with a high-efficiency driver, provide superior illumination for extended service life. The fixture reaches an amazing lumen efficacy up to 140 LM/W.

OPTICS

Aside from its flexibility, the DUO is chosen in indoor commercial applications that require a combination of lighting uniformity, comfort, and higher visibility. These requirements are met with the DUO's PMMA lens that softens and distributes light, and a back lit housing that intensifies the output from the diodes.

APPLICATION

As stated above, application of the DUO is extremely flexible. In installation, the DUO has the features of a classic panel. If a room has T-bar ceilings, the panel can be recessed into the grid. If other placement is required, ATG offers mounting options such as surface mounting kits, drywall flange kits.

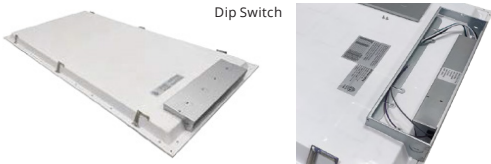

CONSTRUCTION

Considering its robust performance, the DUO is impressively lightweight and streamlined in outward design. Out of package, you can observe a profile of only 1.37 inches, not counting the driver. As a supplemental to this convenience, we have permanently sealed the optical module so that no internal cleaning is required. For guaranteed strength, the DUO is also manufactured with an aluminum face frame and galvanized steel rear housing. For high quality output and sleek appearance, the fixture also features a non-yellowing PS Diffuser and PMMA LED lens.

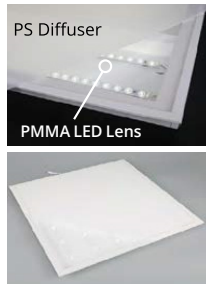

DIMENSIONS

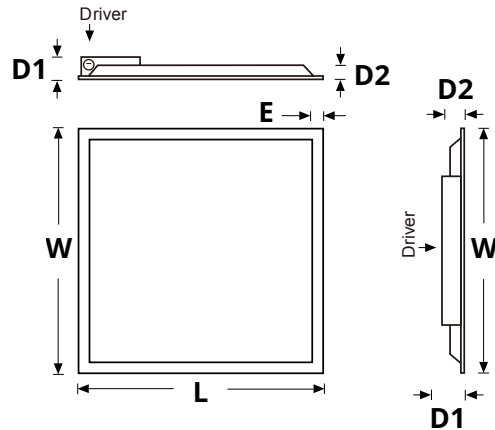

SIZE	PART NO.	LENGTH (L)	WIDTH (W)	DEPTH (D1)	DEPTH (D2)	EDGE (E)
2x2	FPBL22T	23.77"	23.77"	2.16"	1.37"	1.06"

Recorded in inches

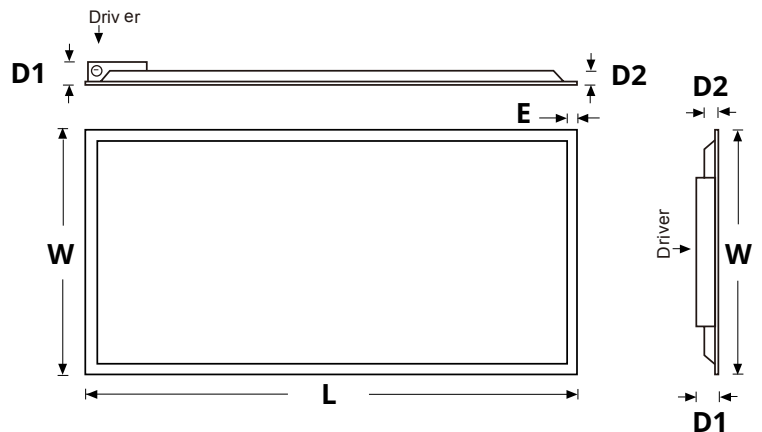

SIZE	PART NO.	LENGTH (L)	WIDTH (W)	DEPTH (D1)	DEPTH (D2)	EDGE (E)
2x4	FPBL24T	47.79"	23.77"	2.16"	1.37"	1.06"

Recorded in inches

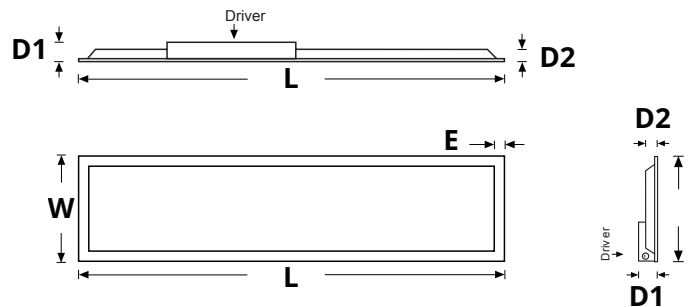

SIZE	PART NO.	LENGTH (L)	WIDTH (W)	DEPTH (D1)	DEPTH (D2)	EDGE (E)
1x4	FPBL14T	47.79"	11.81"	2.16"	1.37"	1.06"

Recorded in inches

LUMEN DATA

Size	Part Number	Default Wattage (W)	3000K		3500K		4000K		4500K		5000K	
			Efficacy (LM/W)	Lumens (Lm)	Efficacy (LM/W)	Lumens (Lm)	Efficacy (LM/W)	Lumens (Lm)	Efficacy (LM/W)	Lumens (Lm)	Efficacy (LM/W)	Lumens (Lm)
1X4	FPBL14T-30W-02	15W	124	1,854	126	1,853	132	1,930	134	1,955	141	2,097
		20W	123	2,367	126	2,475	130	1,930	133	2,624	137	2,717
		25W	120	2,971	122	3,033	126	2,533	129	3,237	133	3,231
		30W	120	3,447	117	3,639	126	3,113	128	3,878	130	3,903
2x2	FPBL22T-30W-02	15W	131	2,011	133	2,043	134	2,088	140	2,108	141	2,147
		20W	129	2,614	128	2,651	130	2,715	135	2,722	137	2,786
		25W	125	3,150	126	3,233	126	3,277	131	3,267	134	3,355
		30W	121	3,605	121	3,650	123	3,743	127	3,733	130	3,833
2X4	FPBL24T-40W-02	25W	132	3,239	132	3,283	133	3,342	137	3,345	141	3,434
		30W	127	3,808	129	3,873	130	3,950	134	3,931	137	4,059
		35W	126	4,333	128	4,403	126	4,488	131	4,489	130	4,601
		40W	120	4,806	123	4,898	127	5,012	128	4,912	131	5,147

LUMEN MAINTENANCE LIFETIME DATA

Model	Ambient Test Temp	Reported Hrs	0 Hrs	25,000 Hrs	TM-21-11 L89@ 54,000	50,000	100,000 Hrs	L70 Hrs Calculated
FPBL24T-40W	25°C/77°F	54,000	1	0.9307	0.8523	0.8627	0.7413	119,000
FPBL22T-30W	25°C/77°F	54,000	1	0.9307	0.8523	0.8627	0.7413	119,000
FPBL14T-30W	25°C/77°F	54,000	1	0.9307	0.8523	0.8627	0.7413	119,000

DLC Reported Hours = Max 6X LM-80 tested duration (ETRB-3030WB-MASD from Ebright Opto-Electronic @ 9,000 Hrs)

ACCESSORIES



EMH-08170-FY Emergency Driver

The EMH-08170-FY from HELPOWER is an UL listed LED emergency driver for field and factory installation allows the same LED fixture to be used for both normal and emergency operation. In the event of a power failure, it switches to the emergency mode and operates the existing fixture for 90 minutes. The unit contains a battery, charger and converter circuit in a single enclosure and is available in different mounting configurations for individual fixture requirements. The EMH-08170-FY will operate an LED array load at 8 watts with constant power at rated output voltage of 170VDC.



Product Highlights

- NFPA101 (Life Safety Code)
- NFPA70 (National Electrical Code)
- Waterproof 2-in-1 LED test switch and indicator light included
- EMI (Radiated and Conducted) FCC Class15B
- Product types reducing product SKUs for emergency options



MOUNTING OPTIONS

1X4 Surface Mount Kit
HAC-CLMB0-0312A0-RS

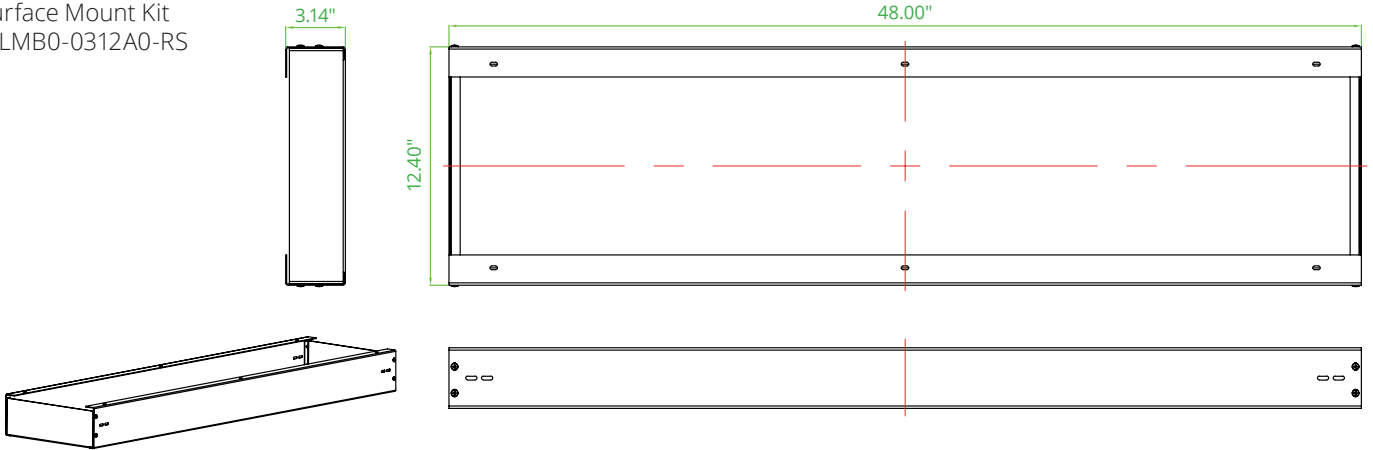

2X2 Surface Mount Kit
HAC-CLMB0-0600A0-RS

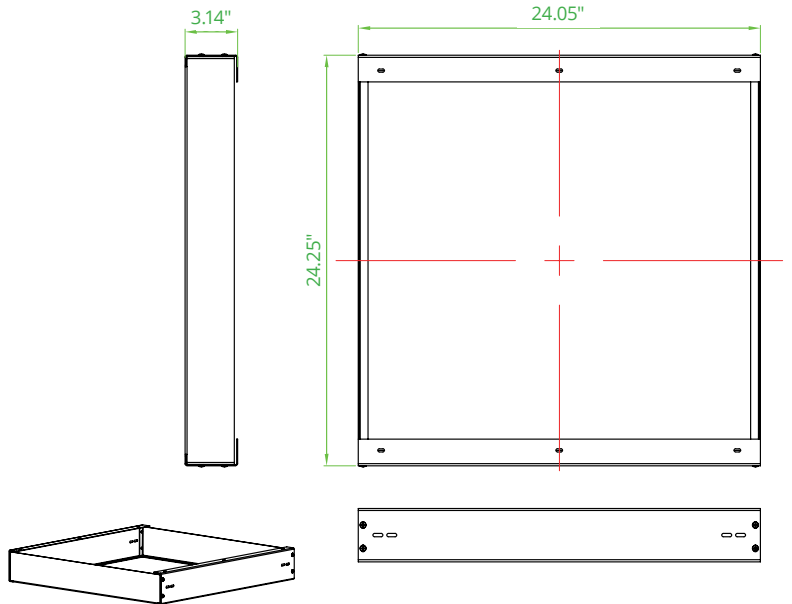

2X4 Surface Mount Kit
HAC-CLMB0-0612A0-RS

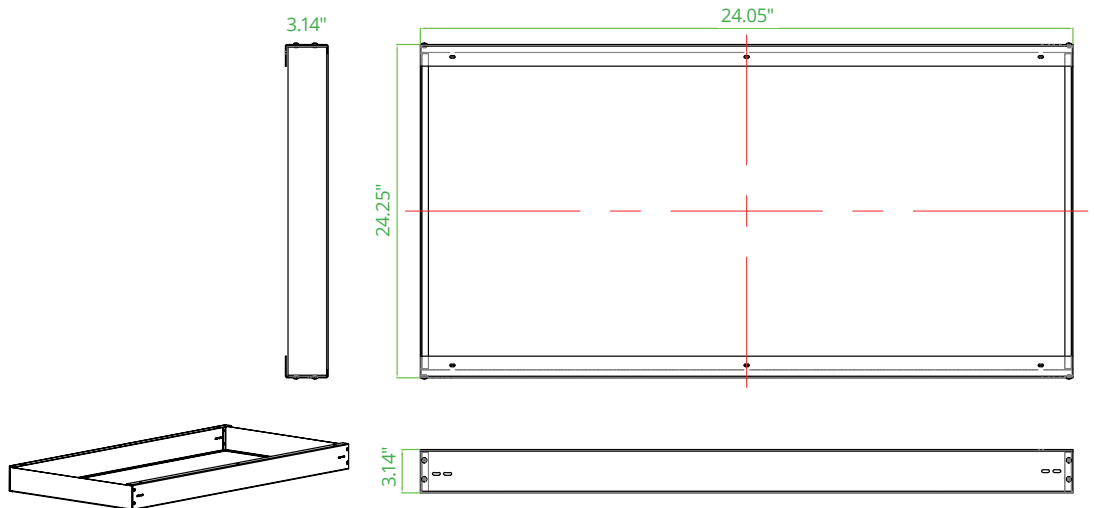

COVERAGE

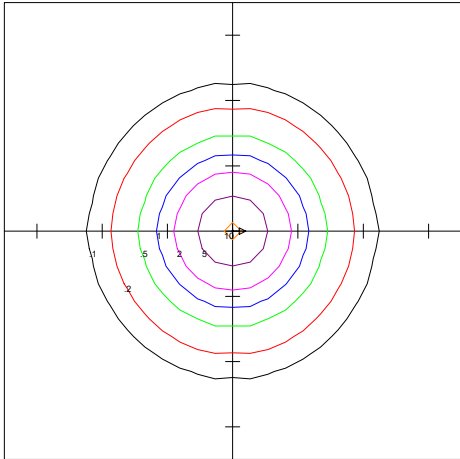

ATG ELECTRONICS
ATG DUO FPBL14-15W-40K-02
47.7"L X 12"W X 2.16"H LED FIXTURE
LED STRIPS WITH PS DIFFUSER

Horizontal Footcandles
Scale: 1 Inch = 10 Ft.
Light Loss Factor = 1.00
Lumens Per Lamp = N.A. (absolute photometry)
Luminaire Lumens = 1929
Mounting Height = 8.00 Ft
Maximum Calculated Value = 11.19 Fc
Arrangement: Single

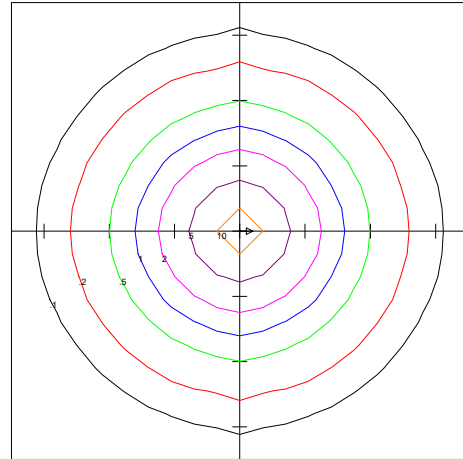

ATG ELECTRONICS
ATG DUO FPBL14-30W-40K-02
47.7"L X 12"W X 2.16"H LED FIXTURE
LED STRIPS WITH PS DIFFUSER

Horizontal Footcandles
Scale: 1 Inch = 10 Ft.
Light Loss Factor = 1.00
Lumens Per Lamp = N.A. (absolute photometry)
Luminaire Lumens = 3776
Mounting Height = 10.00 Ft
Maximum Calculated Value = 12.52 Fc
Arrangement: Single

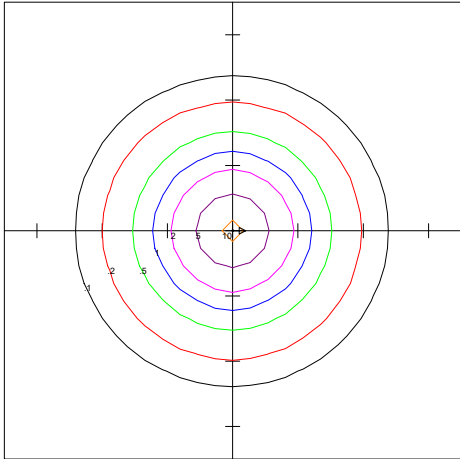

ATG ELECTRONICS
ATG DUO FPBL22-15W-40K-02
23.77"L X 23.77"W X 2.16"H LED FIXTURE
LED STRIPS WITH PS DIFFUSER

Horizontal Footcandles
Scale: 1 Inch = 10 Ft.
Light Loss Factor = 1.00
Lumens Per Lamp = N.A. (absolute photometry)
Luminaire Lumens = 2067
Mounting Height = 8.00 Ft
Maximum Calculated Value = 11.36 Fc
Arrangement: Single

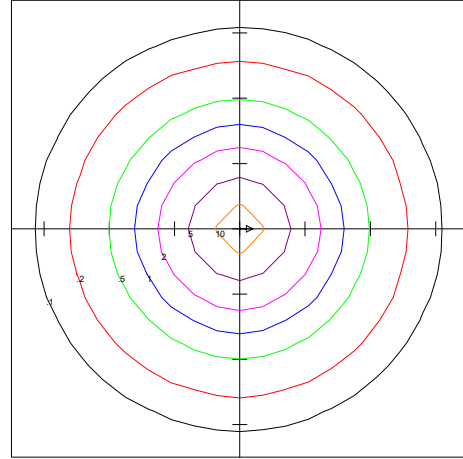

ATG ELECTRONICS
ATG DUO FPBL22-30W-40K-02
23.77"L X 23.77"W X 2.16"H LED FIXTURE
LED STRIPS WITH PS DIFFUSER

Horizontal Footcandles
Scale: 1 Inch = 10 Ft.
Light Loss Factor = 1.00
Lumens Per Lamp = N.A. (absolute photometry)
Luminaire Lumens = 3772
Mounting Height = 10.00 Ft
Maximum Calculated Value = 13.14 Fc
Arrangement: Single

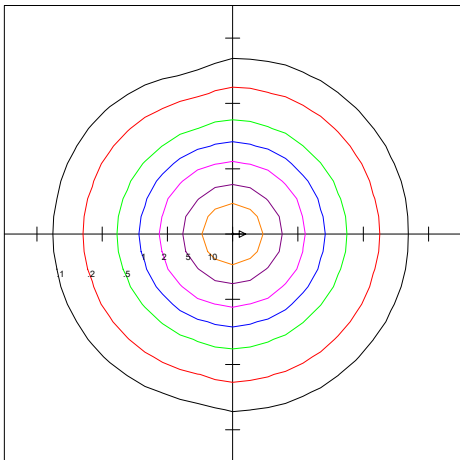

ATG ELECTRONICS
DUO FPBL24-25W-40K-02
47.7"L X 23.77"W X 2.16"H LED FIXTURE
LED STRIPS WITH PS DIFFUSER

Horizontal Footcandles
Scale: 1 Inch = 10 Ft.
Light Loss Factor = 1.00
Lumens Per Lamp = N.A. (absolute photometry)
Luminaire Lumens = 3364
Mounting Height = 8.00 Ft
Maximum Calculated Value = 18.27 Fc
Arrangement: Single

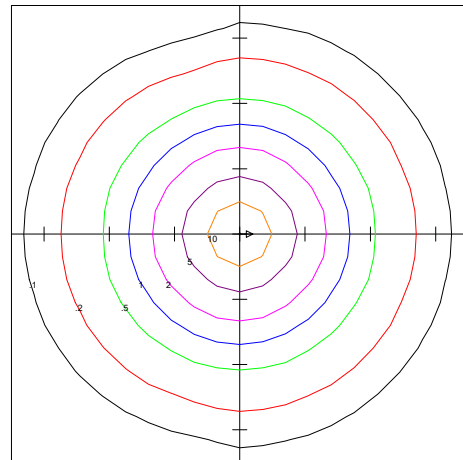

ATG ELECTRONICS
DUO FPBL24-30W-40K-02
47.7"L X 23.77"W X 2.16"H LED FIXTURE
LED STRIPS WITH PS DIFFUSER

Horizontal Footcandles
Scale: 1 Inch = 10 Ft.
Light Loss Factor = 1.00
Lumens Per Lamp = N.A. (absolute photometry)
Luminaire Lumens = 4487
Mounting Height = 10.00 Ft
Maximum Calculated Value = 15.58 Fc
Arrangement: Single

2x2 Drywall Flange Kit

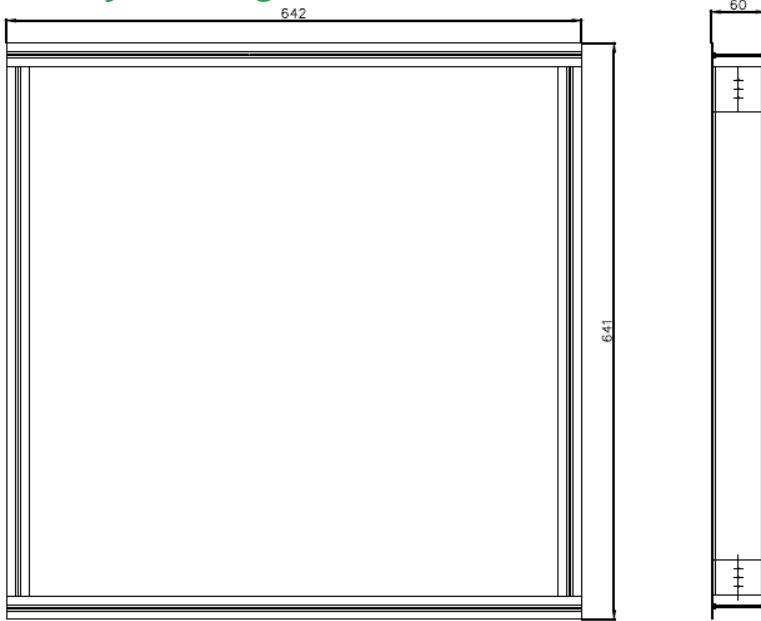

Drywall Mounting Flange Kits	
FK-FPEL22-01	Flange Kit, 2x2
FK-FPEL14-01	Flange Kit, 1x4
FK-FPEL24-01	Flange Kit, 2x4

1x4 Drywall Flange Kit

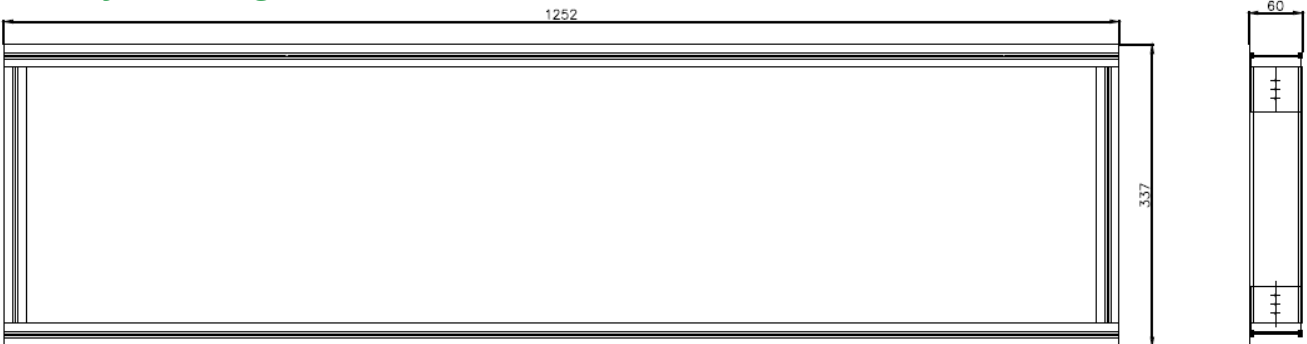

2x4 Drywall Flange Kit

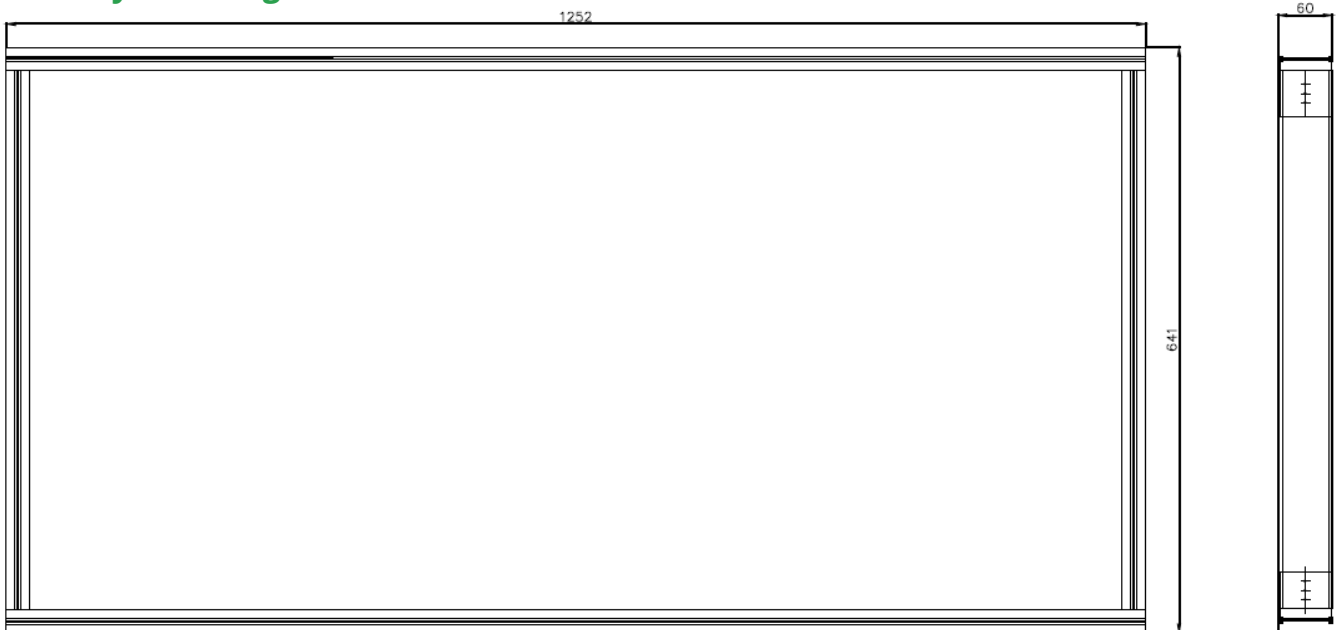



DUO FLAT PANEL

Indoor color and power selectable flat panel fixture

FPBL-T

5 YEAR WARRANTY

ATG Electronics®

Industry Leading 5 Year Limited Warranty

For North American LED Lighting Fixtures

ATG Electronics warrants to the original purchaser of ATG Electronics Domestic LED products listed above that were manufactured for which the ATG Electronics Spec Sheet located on our website contains the words "5 year limited warranty" that, subject to the below terms and conditions of this warranty, when such LED products are properly installed they will comply with ATG Electronics published product specifications for such products and will be free from material defects in material and workmanship for a period of five (5) years from the date of sale by ATG Electronics, or, if lesser, 50,000 hours of operation (at an average of 13.6 hours per day operation). The LED arrays in the Product(s) will be considered defective in material or workmanship only if a total of 15% or more of the individual light emitting diodes in the Product(s) fail to illuminate.

The above express limited warranty is extended by ATG Electronics® only to the original or first end-user purchaser and only for the original installed location. This warranty only applies to electronics purchased after June 1, 2017. This warranty is non-transferrable, whether by assignment or operation of law. The original purchaser must provide warranty claims to ATG Electronics within the warranty period promptly upon discovery and in accordance with ATG Electronics Return and Repair Procedures as outlined within this document.

Should any defects be found by ATG Electronics upon its inspection of the properly returned product, ATG Electronics sole responsibility and liability under this warranty will be, at its option, to either repair or replace the defective part or parts or else make available a new replacement unit that will provide equal or better performance. All decisions regarding the existence or non-existence of defects or otherwise affecting the warranty shall be made by ATG ELECTRONICS and shall be final and binding on all parties. Where a defective LED product is replaced under this warranty, the balance of the original warranty period shall remain effective.

Conditions and Exclusions

This warranty is conditioned upon proper installation, use and maintenance. This warranty will automatically become null and void and shall not be applicable to any LED fixture which (i) has not been timely paid for, (ii) is not installed and operated in accordance with the current edition of The National Electric Code (NEC), the Standards for Safety of Underwriters' Laboratory, Inc. (UL) or with ATG Electronics instructions and guidelines, (iii) has been moved from its original installation, (iv) has been installed within an area that has exposure to sulfur or any area with high acidic compounds in use, (v) has been operated in an ambient temperature or humidity that is higher than the stated ambient operating range from datasheets, (vi) has been subjected to a lightning strike, power surge or overvoltage condition, (vii) has its LED Board subjected to static electricity due to failure to discharge same prior to connecting or disconnecting the lead from the LED board, (viii) was not installed and/or operated in accordance with ATG Electronics instructions and guidelines, (ix) has been mishandled, misused, abused, tampered with, modified or altered by anyone other than ATG ELECTRONICS, (x) has been subjected to abnormal stresses and operating conditions, or (xi) has been operated without overvoltage and lightning protection devices in place.

Limitations

Disclaimers & Limitations of Liability

The foregoing warranty is exclusive of all other statutory, written or oral warranties and no other warranties of any kind, statutory, by operation of law or course of performance, or otherwise, are given, herein expressed or otherwise received. EXCEPT AS EXPRESSLY PROVIDED ABOVE, ATG ELECTRONICS DISCLAIMS ALL REPRESENTATIONS, WARRANTIES AND CONDITIONS OF ANY KIND, EXPRESS OR IMPLIED, REGARDING THE LED PRODUCTS AND ITS SERVICES, INCLUDING, WITHOUT LIMITATION, THE IMPLIED WARRANTIES OF MERCHANTABILITY AND FITNESS FOR A PARTICULAR USE OR PURPOSE.

LIMITATION OF LIABILITY. Other than the obligation to repair or replace as provided above, ATG Electronics shall have no liability for any losses, expenses or damages as a result of the installation, use, inability to use, removal or replacement of any LED product. ATG Electronics will not under any circumstances whether as a result of breach of contract, breach of warranty, tort, strict liability or otherwise be liable for consequential, incidental, special or exemplary damages including but not limited to, loss of profits or revenues, loss of any other goods or associated equipment or damage to any associated equipment, cost of capital, cost of substitute products, facilities or services, down time cost or claims of claimant's customers. ATG Electronics liability on any claim of any kind for any loss or damages arising out of, resulting from or concerning any LED product, any aspect of this warranty or for any products or services furnished hereunder shall not exceed the price of the fixture which gives rise to the claim.

Return and Repair Procedures

All warranty requests and or questions are to be directed to ATG Electronics Customer Service Department (CSD) at 888-618-7298. If deemed necessary, the CSD will issue a Returned Merchandise Authorization (RMA) number which must be included on both the packing slip of the component or fixture being returned and on the outside of the box. You must include your name and contact information, including your email address, on the packing slip so that we can contact you easily. Each component or fixture must be packaged very carefully and properly so as to prevent damages in shipment and must be shipped freight prepaid. Please obtain a proof of delivery to ensure that the material is received.

Once the component or fixture has been received and tested, an evaluation report will be provided to the end user via email. This report will clarify the following:

- A) The component / fixture is covered under the warranty policy and will either be repaired or replaced.
- B) The component / fixture is not covered under the warranty policy and the reason for this determination.

If ATG ELECTRONICS determines that the component or fixture is covered under the warranty, then the appropriate repairs will be started or a replacement fixture will be manufactured and shipped. Please note that in the event the returned component or fixture is found not to be covered under this warranty, you may be subject to a labor charge for the evaluation process and will be responsible for all return shipping charges and fees. For components and fixtures determined to be covered under this warranty prior to the first anniversary of the Sale Date, the repaired or replacement component or fixture will be returned to you at no charge. You will be responsible for all other shipping charges.

No Labor Reimbursement

All components and fixtures determined to be covered by this warranty as provided above, will be repaired or replaced at no charge to the customer, however, except as expressly provided above with respect to recessed and linear fixtures during the first year, the customer must hire and pay for an electrician to remove and reinstall such components and fixtures. No labor costs will be covered for the removal or reinstallation of any components or fixtures. The warranty does not cover modifications, repairs or replacements, or the related labor or materials costs, that may be necessary to facilities or third party products in connection with the removal, repair, or replacement of any LED product under this warranty.